

Parameter List (参数表)

station (位数)	1	2	3	4	5	6	7	8	9	10	11	12	13	14	15	16	17	18	19	20
P: mm(毫米)	29.5	40	50.5	61	71.5	82	92.5	103	113.5	124	134.5	145	155.5	166	176.5	187	197.5	208	218.5	229
L: mm(毫米)	20	30.5	41	51.5	62	72.5	83	93.5	104	114.5	125	135.5	146	156.5	167	177.5	188	198.5	209	219.5

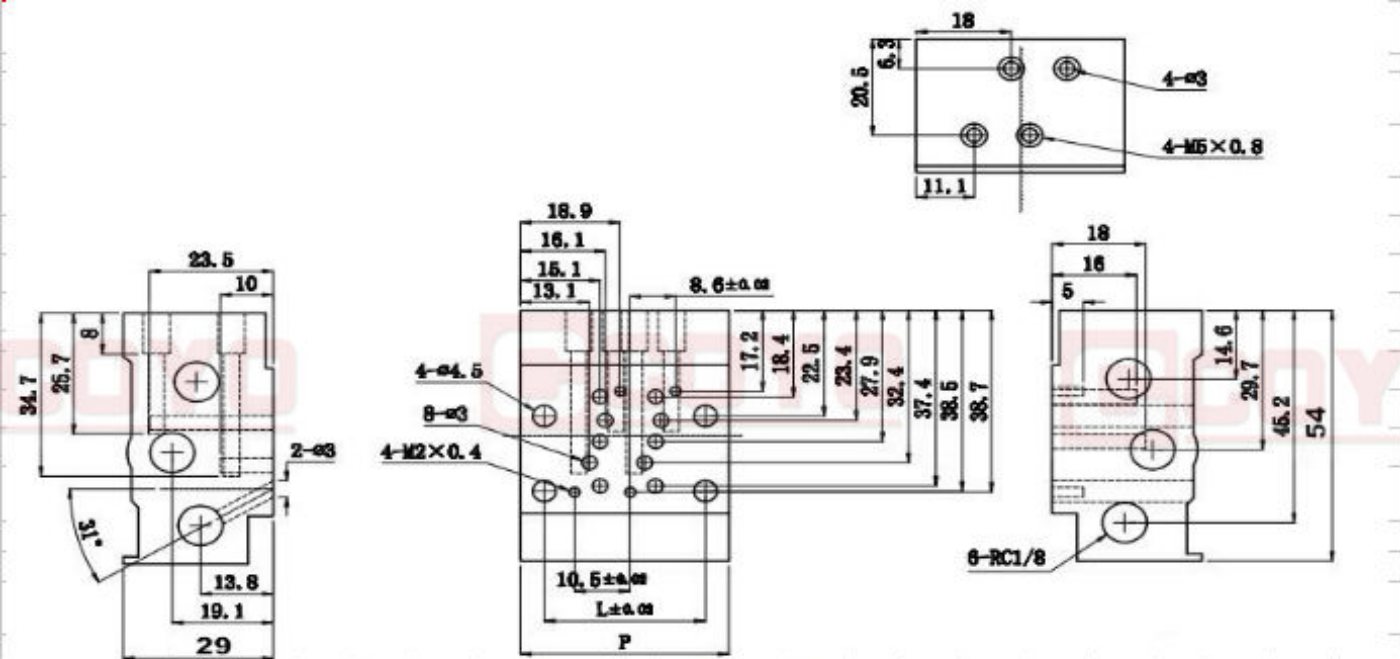

Parameter List (参数表)

station (位数)	1	2	3	4	5	6	7	8	9	10	11	12	13	14	15	16	17	18	19	20
P: mm (毫米)	29	39.5	50	60.5	71	81.5	92	102.5	113	123.5	134	144.5	155	165.5	176	186.5	197	207.5	218	228.5
L: mm (毫米)	20	30.5	41	51.5	62	72.5	83	93.5	104	114.5	125	135.5	146	156.5	167	177.5	188	198.5	209	219.5

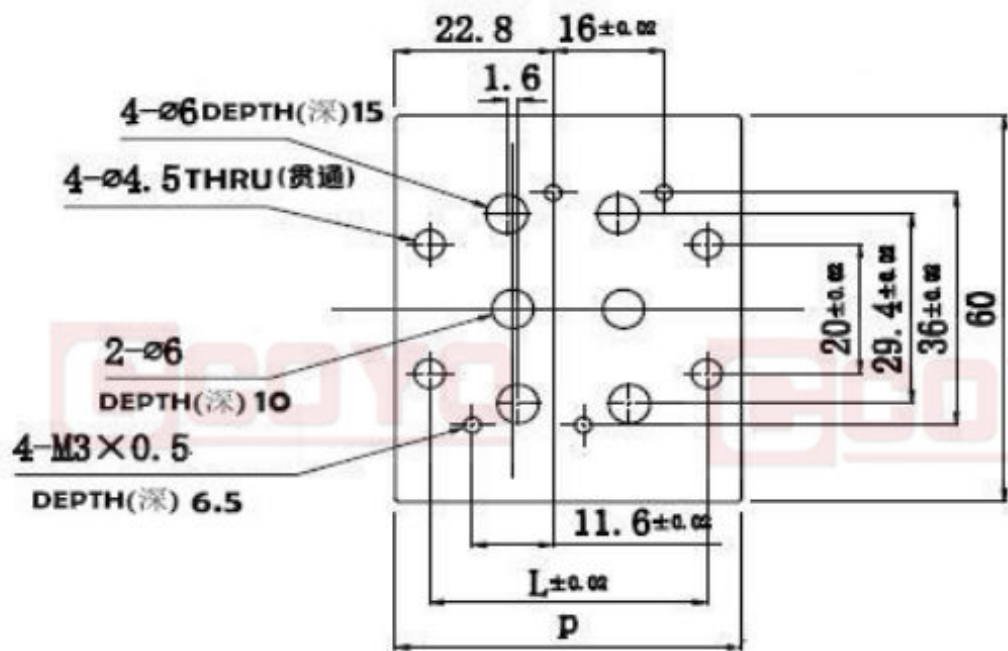
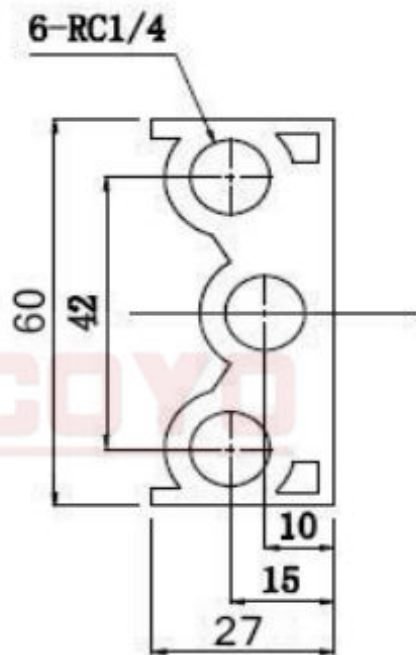

Parameter List (参数表)

station(位数)	1	2	3	4	5	6	7	8	9	10	11	12	13	14	15	16	17	18	19	20
P: mm (毫米)	34	50	66	82	98	114	130	146	162	178	194	210	226	242	258	274	290	306	322	338
L: mm (毫米)	24	40	56	72	88	104	120	136	152	168	184	200	216	232	248	264	280	296	312	328

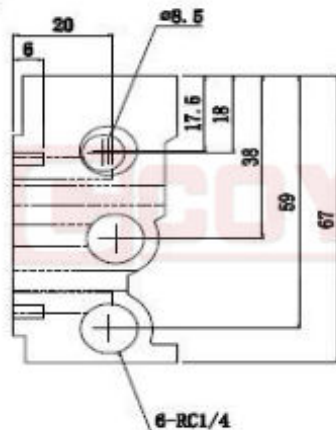
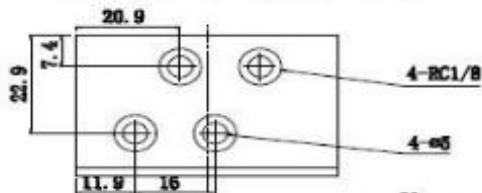
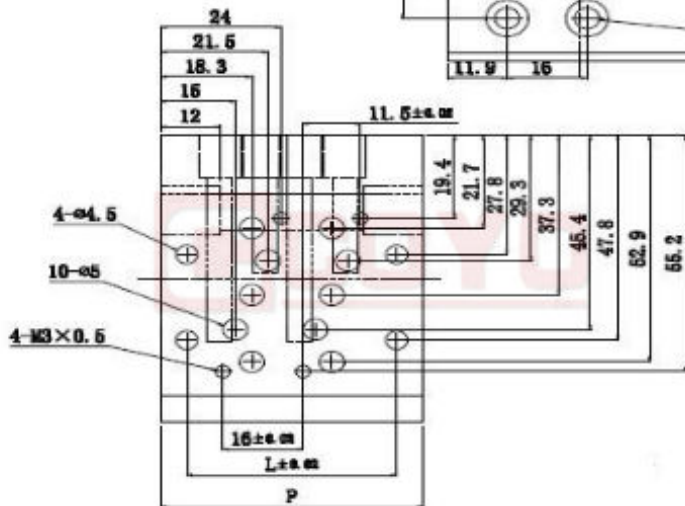
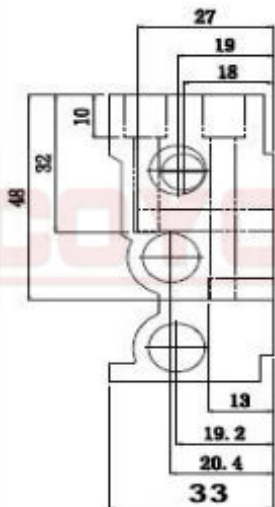

Parameter List (参数表)

station (位数)	1	2	3	4	5	6	7	8	9	10	11	12	13	14	15	16	17	18	19	20
P: mm (毫米)	36.5	52.5	68.5	84.5	100.5	116.5	132.5	148.5	164.5	180.5	196.5	212.5	228.5	244.5	260.5	276.5	292.5	308.5	324.5	340.5
L: mm (毫米)	26	42	58	74	90	106	122	138	154	170	186	202	218	234	250	266	282	298	314	330

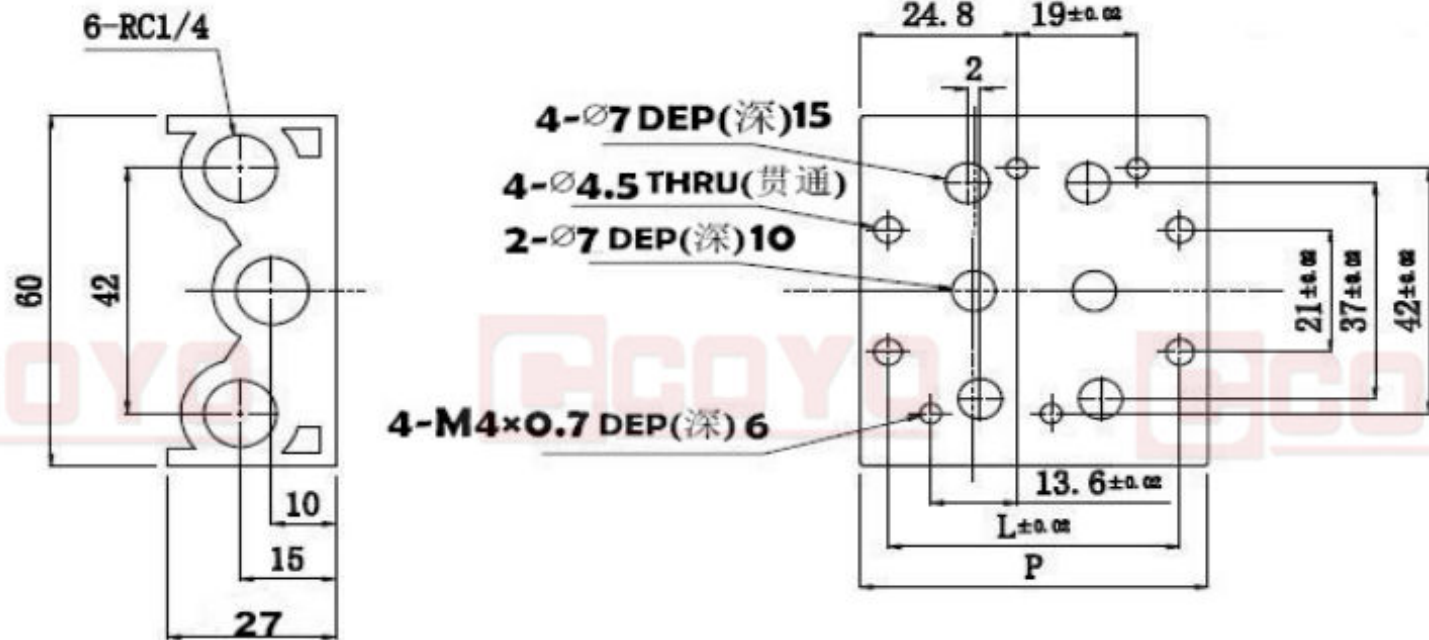

Parameter List (参数表)

station (位数)	1	2	3	4	5	6	7	8	9	10	11	12	13	14	15	16	17	18	19	20
P: mm (毫米)	36	55	74	93	112	131	150	169	188	207	226	245	264	283	302	321	340	359	378	397
L: mm (毫米)	27	46	65	84	103	122	141	160	179	198	217	236	255	274	293	312	331	350	369	388



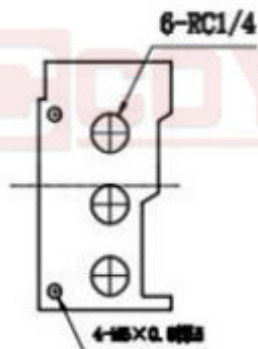
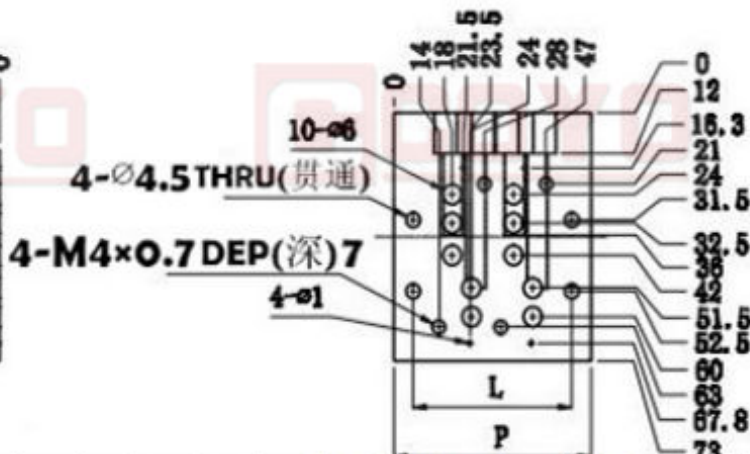
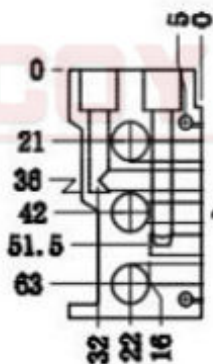
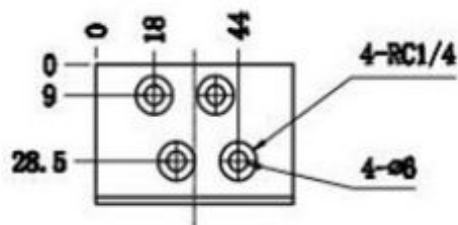

Parameter List (参数表)

station (位数)	1	2	3	4	5	6	7	8	9	10	11	12	13	14	15	16	17	18	19	20
P: mm (毫米)	42	61	80	99	118	137	156	175	194	213	232	251	270	289	308	327	346	365	384	403
L: mm (毫米)	30	49	68	87	106	125	144	163	182	201	220	239	258	277	296	315	334	353	372	391

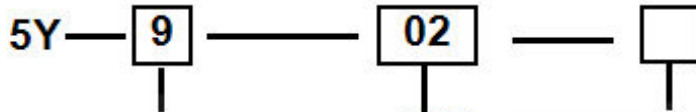

**Manifold series**  
(汇流板)

9	SY9		20
---	-----	--	----

**station(位数)**

01	1 station
...	...
20	20 stations

**thread type**  
(螺纹的种类)

RC	RC
G	G
N	NPT

**blanking plate(盲板)**

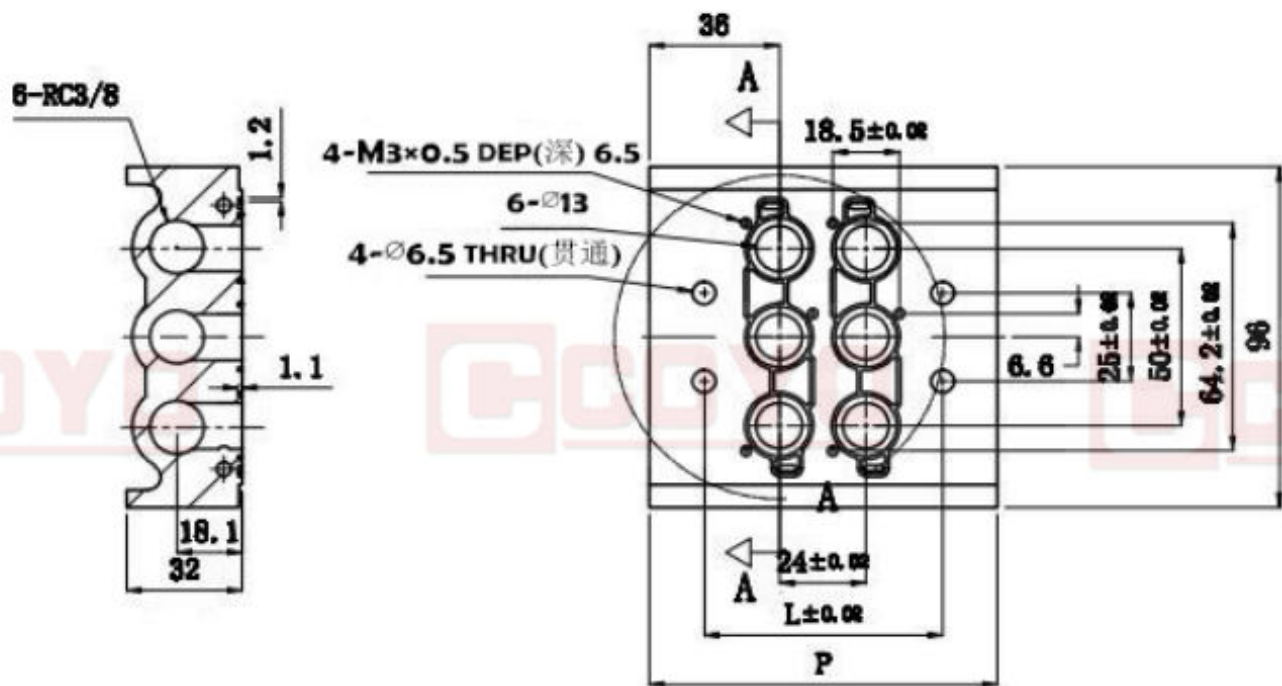

Parameter List (参数表)

station(位数)	1	2	3	4	5	6	7	8	9	10	11	12	13	14	15	16	17	18	19	20
P: mm (毫米)	72.5	96.5	120.5	144.5	168.5	192.5	216.5	240.5	264.5	288.5	312.5	336.5	360.5	384.5	408.5	432.5	456.5	480.5	504.5	528.5
L: mm (毫米)	42	66	90	114	138	162	186	210	234	258	282	306	330	354	378	402	426	450	474	498



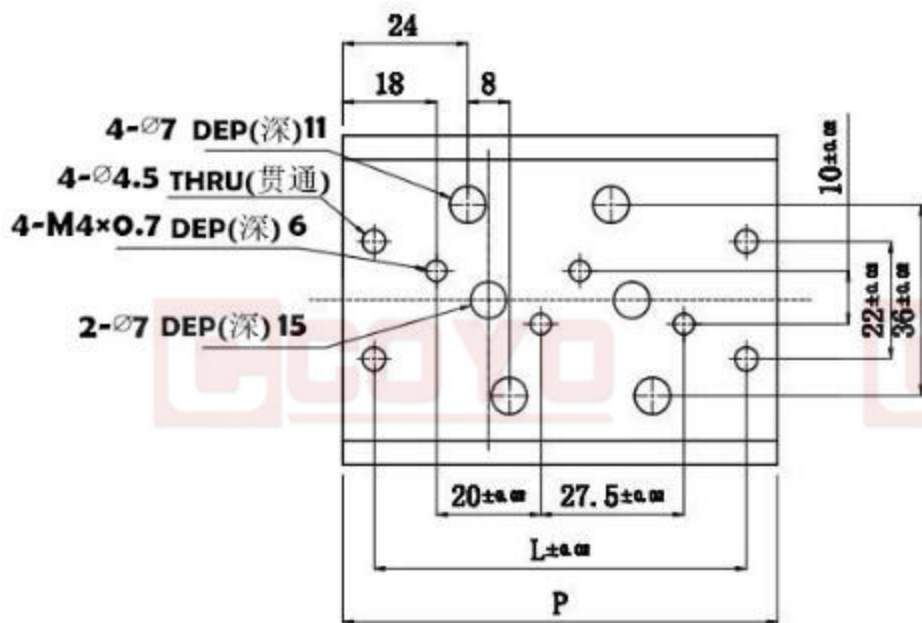
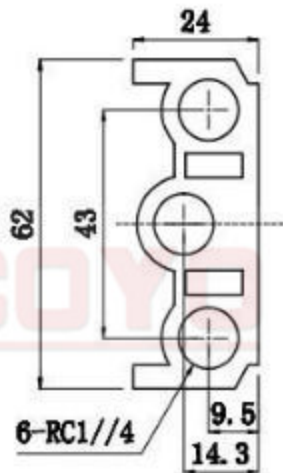

Parameter List (参数表)

station (位数)	1	2	3	4	5	6	7	8	9	10	11	12	13	14	15	16	17	18	19	20
P: mm(毫米)	56	83.5	111	138.5	166	193.5	221	248.5	276	303.5	331	358.5	386	413.5	441	468.5	496	523.5	551	578.5
L: mm(毫米)	44	71.5	99	126.5	154	181.5	209	236.5	264	291.5	319	346.5	374	401.5	429	456.5	484	511.5	539	566.5

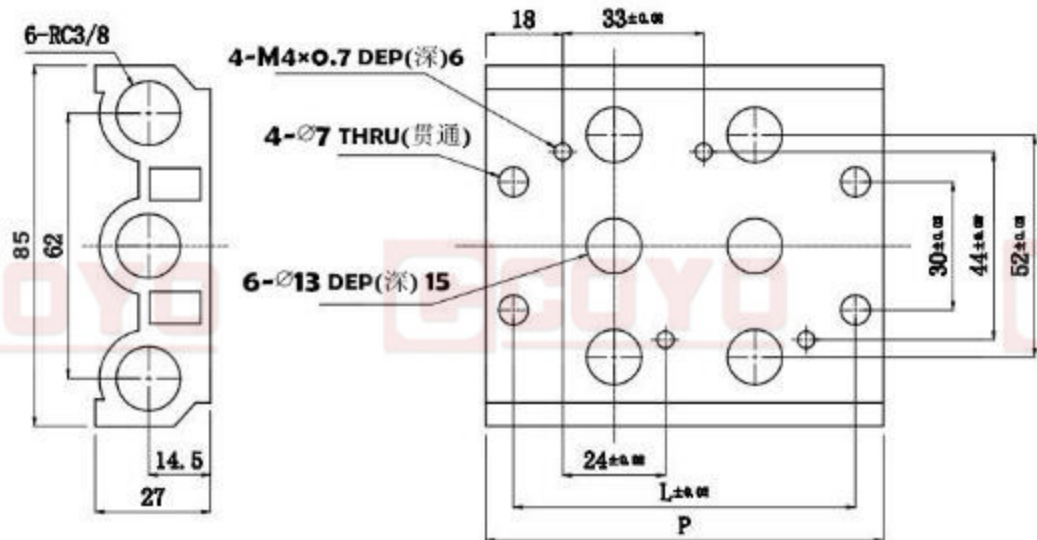

Parameter List (参数表)

station (位数)	1	2	3	4	5	6	7	8	9	10	11	12	13	14	15	16	17	18	19	20
P: mm(毫米)	60	93	126	159	192	225	258	291	324	357	390	423	456	489	522	555	588	621	654	687
L: mm(毫米)	47	80	113	146	179	212	245	278	311	344	377	410	443	476	509	542	575	608	641	674