

Foshan City Coyo Precision Machinery Manufacturing Co. Ltd.
Guangdong Coyo Precision Machinery Manufacturing Co. Ltd.

Factory Address:
No.3, Leyuan Road, Industrial Park, Lechang Zone, Shaoguan City, Guangdong Province.
TEL: (+86)-0751-5575317 FAX: (+86)-0751-5575817

Sales Address:
F2, Building 3, Jidefu Science and Technology Innovation Park, No. 1 Husband South Road, Chancheng District, Foshan
TEL: (+86)-0757-82800517 FAX: (+86)-0757-82800527

Eastern China Agency:
113-114 Room, 110th Building, Wuzhou International Industrial Expo Yard, Jincheng Road East, New District Wuxi City, Jiangsu Province.
TEL: (+86)-0510-88999017 FAX: (+86)-0510-88994517

Changsha City Agency:
1st Floor, 3rd Unit, 24th Building, B Group Huamei Jiayuan, Boyang Residential Quarter, Yuhua District, Changsha City, Hunan Province, P.R. China
TEL: (+86)-0731-82562217 FAX: (+86)-0731-85417650

Wenzhou Agency:
1-A18 unit, South zhongchuang electronic zone, Liushi Town, Yueqing City, Zhejiang Province.
TEL: (+86)-0577-62778882 Phone: (+86)-18222974017

Ningbo Agency:
5 Unit, Jishan Area, Xikou Town, Fenghua District, Ningbo city.
Fax: (+86)-0574-88381087 TEL: (+86)-15825590998

Chinese Website: <http://www.fskeyou.com>
English Website: <http://www.en.fskeyou.com>
E-mail: fskeyou@163.com



佛山科优精密机械制造有限公司
FOSHAN CITY COYO PRECISION MACHINERY MANUFACTURING CO., LTD

广东科优精密机械制造有限公司
GUANGDONG COYO PRECISION MACHINERY MANUFACTURING CO. LTD

佛山科优精密机械制造有限公司
广东科优精密机械制造有限公司

工厂地址：韶关市乐昌市乐昌产业转移工业园乐园大道3号
电话：0751-5575317 传真：0751-5575817

销售部电话：佛山市禅城区华宝南路1号基德福科技创新园3座2楼
电话：0757-82800517 传真：0757-82800527

华东办事处：无锡市新区金城东路五洲国际工业博览城 110 栋 113-114 号
电话：0510-88999017 传真：0510-88994517

长沙办事处：长沙市雨花区酃阳小区华美家园 B 区 24 栋三单元一楼（雨花机电市场附近）
电话：0731-82562217 传真：0731-85417650

温州办事处：乐清市柳市镇浙南众创电子城南 1-A18（瑞安市凯力奥气动元件有限公司）
电话：0577-62778882 18657788887

宁波办事处：宁波市奉化区溪口镇崎山小区 5 号
传真：0574-88381087 电话：15825590998

网址：www.fskeyou.com www.en.fskeyou.com
E-mail: fskeyou@163.com



扫一扫浏览科优网站

 本广告资料中所引用的其他品牌信息仅用于说明本公司系列产品的相关内容，并不代表侵犯与之相关公司的权利。因技术升级或者生产工艺改进恕不另行通知。订货时请随时联系相关人员，以证实有关信息的准确性。（2019年02月版本）

因为专业 所以卓越
www.fskeyou.com



SERVICE DILIGENTLY
CUSTOMER FIRSTLY
用心服务·客户至上

COMPANY PROFILE

Guangdong Coyo Precision Machinery Manufacturing Co. Ltd. (Foshan city Coyo Precision Machinery Manufacturing Co. Ltd.), a technology enterprise specialized in designing, producing, selling pneumatic solenoid valve manifold, simple fieldbus valve base and hydraulic manifold. The products are widely used in automotive, packaging machines, lithium battery equipment, smart phone production line and other industries.

In 2017, we invested and built a new factory covering an area of 12,000 square meters in Industrial Park, Lechang Zone, Shaoguan City, Guangdong Province, and it has been completed and put into use.

New journey is beginning. On the basic of promoting the manifold business actively, COYO creatively develop the business of hydraulic manifold and simple fieldbus valve base. To cater the market demand, we adopt advanced process technology, perfect product quality inspection system and automatic aluminum extrusion production line to ensure the good quality.

COYO has a highly sophisticated technical talent team, strong research and development strength. Because of the economic, interchangeable advantage, the independent researching and developing simple fieldbus valve base was accepted by clients quickly.

With the concept of Professional, innovative, realistic and honest, we strive for survival by quality, seek development through service, try our best to satisfy our customers.

The high hardness aluminum material is produced by COYO as well. It uses imported CNC machines for thrilling, including Hass, Youjia, Brother brand. Each one goes by wire drawing, polishing and anodizing after CNC process. Strict entire process quality control system ensure the best quality.

In order to offer fast, convenience service for the clients in Eastern, Northern and Central China, we established the finished product warehouses in Wuxi, Changsha, Tianjin, Wenzhou, Ningbo city, to shorten pick up time, reduce logistics cost.

Complete various of products are covered, including Parker, AirTAC, MINDMAN, SMC, CKD, KOGANEI, KURODA, FESTO, CHELIC, SHAKO, Norgren and ISO5599/1 (single and parallel valve manifold) and block splitter. More than 10 brands, 80 series, 1200 kinds of products in our catalog. In recent years, we cooperate with more and more main domestic pneumatic element factories as OEM vendor.

Because professional, so excellence. Sincerely welcome customers at home and abroad. Customized with sample drawing is also greeted.

企业简介

广东科优精密机械制造有限公司（佛山市科优精密机械制造有限公司），是一家专业研发、设计、生产、销售气动电磁阀汇流板、总线阀岛、总线通讯阀岛、液压油路块的综合型科技企业。产品被广泛应用在汽车、包装、锂电、3C等智能装备自动化产线。

公司于2017年在广东省韶关市乐昌产业转移工业园内投资建设占地12000余平方米、建筑面积9000余平方米的新工厂，现已建成并投入使用。

新起点新征程，科优在积极推进原有汇流板业务的情况下，创新开发出总线阀岛和液压油路块等新产品。采用先进的加工设备、配合成熟的工艺技术、健全的产品质量检验体系，从根本上保证产品质量，不断开发适应市场需求的各种标准及非标件。

科优拥有高尖端的技术人才队伍，研发实力雄厚，自主研发的现场总线筒易阀岛因其经济性、通用性的优点，自推出后得到广大客户的肯定。最新推出的液压油路块，具有质量轻、散热好、坚固耐用、美观等优点，正逐步成为客户的首选。

科技改变世界，优质引领未来，秉承“专业、创新、求实、诚信”的理念，以质量求生存，以研发求发展。公司从研发、工业铝合金型材挤压、加工、装配，是目前行业内拥有完整的产业链和成熟的工艺技术以及全程严格的质量监控体系，确保了一流的产品质量。为了给华东、华中、华北地区客户提供更优质、快捷、方便的服务，公司在无锡、长沙、温州、宁波设立的办事处及成品仓库，努力缩短客户获取产品的时间，降低客户的物流成本。

我司汇流板产品种类齐全，有配套 Parker（派克）、AirTAC（亚德客）、MINDMAN（金器）、SMC、CKD、KOGANEI（小金井）、KURODA（黑田精工）、FESTO（费斯托）、CHELIC（气立可）、SHAKO（新恭）、Norgren（诺冠）及ISO5599/1系列（单底座、连座）、气路分配器、汇流条等10余个品牌100多个系列1800余种型号以及众多非标定制产品，是国内目前产品系列相对完整、品种较为齐全的气动汇流板制造企业。

因为专业，所以卓越！竭诚欢迎国内外新老客户光临指导，来图、来样定做。

集线阀岛

通用式阀岛



下插式阀岛



阀岛选型

型号表示方式

通用式阀岛

特点：沿用常规汇流板，加上集线模块，通用性强，价格低。

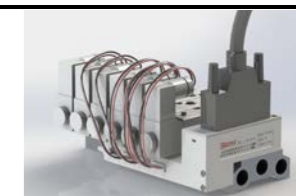

F1- (VUVG-L14-B52-T-G18-1H2L-W1)-04-A0B4 - LY -G-N

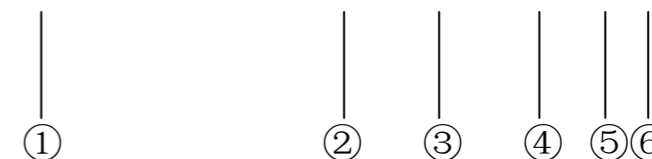

①代码：选用电磁阀具体型号(额定电压 DC24V, 选用导线引出方式为插座式)。如单双电控阀同时存在，只填写单电控阀。

②代码：所有电磁阀位数， 04-24 (单电控最大支持 24 位，双电控最大支持 12 位)。

例如：04 代表 4 位

③代码：单/双电控电磁阀数量 (需满足 $A+2B \leq 24$)

A(单电控)	B(双电控)
0-24	0-12

④代码：汇流板表面处理 (默认)

前代码	后代码
拉丝 (L)	亚光 (Y)

⑤代码：汇流板进排气孔螺纹 (默认与电磁阀牙型种类一致)

代码	G	R	N	M
螺纹	G 螺纹	RC 螺纹	NPT 螺纹	公制螺纹

⑥代码：提供电磁阀安装用的密封垫和螺丝 (默认客户自备电磁阀)

客户自备	需我司提供
Y	N

注：DB/MIL 型接头线缆需另外选型，本型号不包括该线缆。插座默认按 DB 型发货。

型号表示方式

通用式阀岛

特点：定制底板，产品一体式全铝合金设计，外形更美，价格较 F1 高一些。

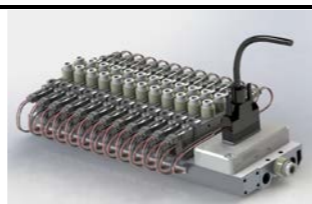

F2- (VUVG-L14-B52-T-G18-1H2L-W1)-04-A0B4 - PL -G-N

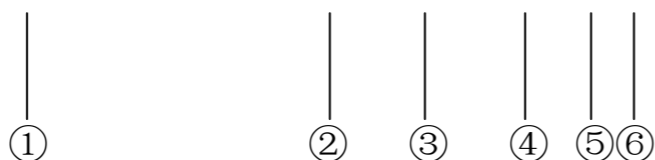

①代码：电磁阀具体型号(额定电压 DC24V)。本阀岛适应以下系列电磁阀（选导线引出为插座式）。如单双电控阀同时存在，只填写单电控阀。安装尺寸与下述电磁阀相近的，也可定制。

牌子	系列
FESTO	VUVG -L10/LK10
	VUVG -L14/LK14
SMC	SY3□20
	SY5□20
	SY7□20
亚德客	4V100M
	4V200M
CKD	4GD1
	4GD2

②代码：所有电磁阀位数， 04-24（单电控最大支持 24 位，双电控最大支持 12 位）。

例如：04 代表 4 位

③代码：单/双电控电磁阀数量（需满足 $A+2B \leq 24$ ）

A(单电控)	B(双电控)
0-24	0-12

④代码：汇流板表面处理（默认）

前代码	后代码
喷砂 (P)	亮光 (L)

⑤代码：汇流板进排气孔螺纹（默认与电磁阀牙型种类一致）

代码	G	R	N	M
螺纹	G 螺纹	RC 螺纹	NPT 螺纹	公制螺纹

⑥代码：提供电磁阀安装用的密封垫和螺丝（默认客户自备电磁阀）

客户自备	需我司提供
Y	N

注：DB 接头线缆需另外选型，本型号不包括该线缆。

型号表示方式

下插式阀岛

特点：定制底板，产品一体式全铝合金设计，外形更美，为特定电磁阀定做。



F3- (4V2108B)- 04- LY -R-N

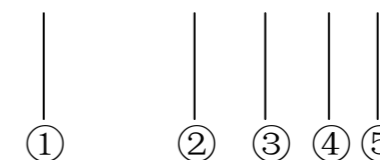

①代码：选用电磁阀具体型号(额定电压 DC24V)。

本阀岛适应具备下插式功能的部分电磁阀。现有量产型号 4V210，如需要其他型号请咨询我司销售。

②代码：所有电磁阀位数， 04-14（仅支持单电控电磁阀）。

例如：04 代表 4 位

③代码：汇流板表面处理（默认）

前代码	后代码
拉丝 (L)	亚光 (Y)

④代码：汇流板进排气孔螺纹（默认与电磁阀牙型种类一致）

代码	G	R	N	M
螺纹	G 螺纹	RC 螺纹	NPT 螺纹	公制螺纹

⑤代码：提供电磁阀安装用的密封垫和螺丝（默认客户自备电磁阀）

客户自备	需我司提供
Y	N

注：DB 接头线缆需另外选型，本型号不包括该线缆。

型号表示方式

连接线缆

F1 阀岛适用线缆:



DB25 — S — 14 — 150

记号	接头	记号	接头	记号	可控线圈数	记号	线长
DB25	DB 接头	S	单头	14	14	150	1.5 米
MI26	牛角接头	D	双头	24	24	300	3 米
							定制

*线缆常规库存是单头 1.5 米和 3 米，如选用其他规格（双头、定制米数），会适当延长交货期。

*DB25 可选可控 14 线圈或 24 线圈（默认按实际线圈数选择），MI26 只可选控制 24 线圈。

F2 阀岛适用线缆:



DB25 — S — 14 — 150

记号	接头	记号	可控线圈数	记号	线长
S	单头	14	14	150	1.5 米
D	双头	24	24	300	3 米
					定制

*线缆常规库存是单头 1.5 米和 3 米，如选用其他规格（双头、定制米数），会适当延长交货期。

型号表示方式

F3 阀岛适用线缆:



DB15 — S — 14 — 150

记号	接头	记号	线长
S	单头	150	1.5 米
D	双头	300	3 米
			定制

*线缆常规库存是单头 1.5 米和 3 米，如选用其他规格（双头、定制米数），会适当延长交货期。

外形尺寸

通用式阀岛

F1 阀岛

F1 阀岛沿用各自电磁阀原有的汇流板型材，所以没有统一的尺寸。下述是集线模块尺寸

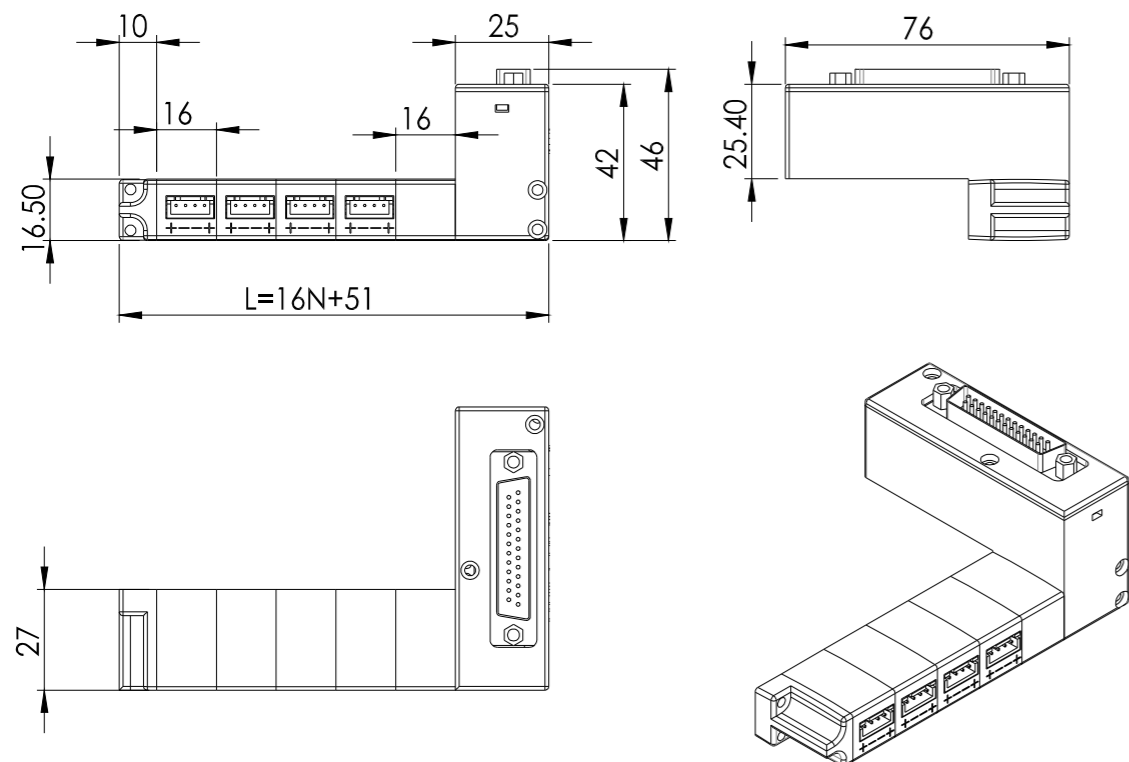

位数	4	5	6	7	8	9	10	11	12
L	115	131	147	163	179	195	211	227	243

例子如下：SY5120 集线阀岛 10 位

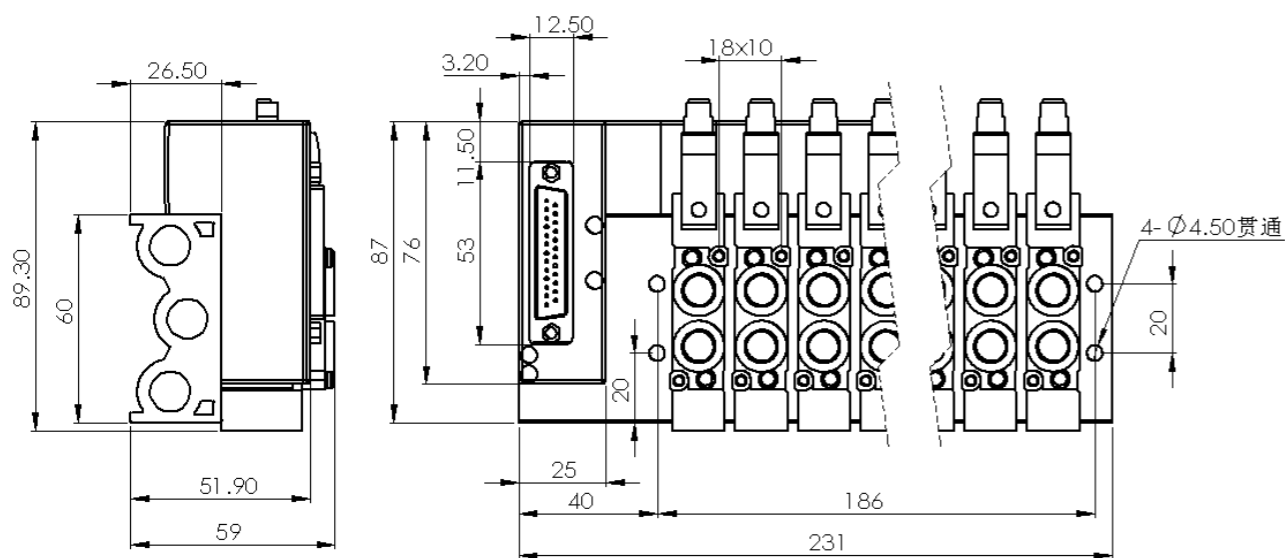

外形尺寸

F2 阀岛

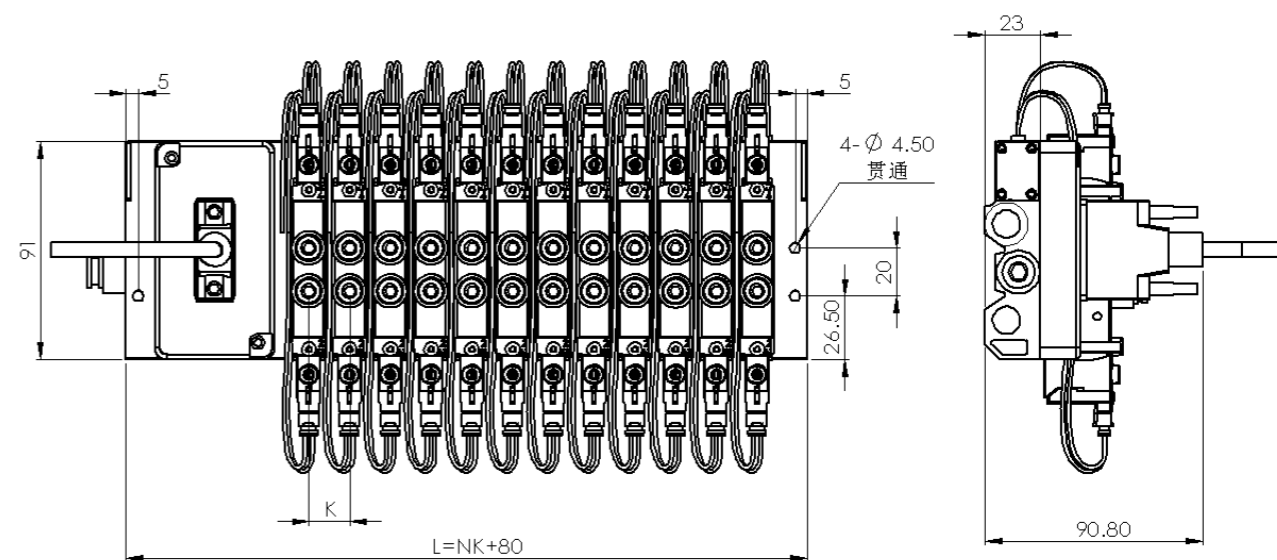

位数	4	5	6	7	8	9	10	...	24
L	4K+80	5K+80	6K+80	7K+80	8K+80	9K+80	10K+80	...	24K+80

*K 值为电磁阀间距（一般为普通汇流板间距+1mm）

下插式阀岛

F3 阀岛

本阀岛为定制开发产品，不同电磁阀的阀岛尺寸有差异，以下是 4v210 下插式阀岛尺寸图

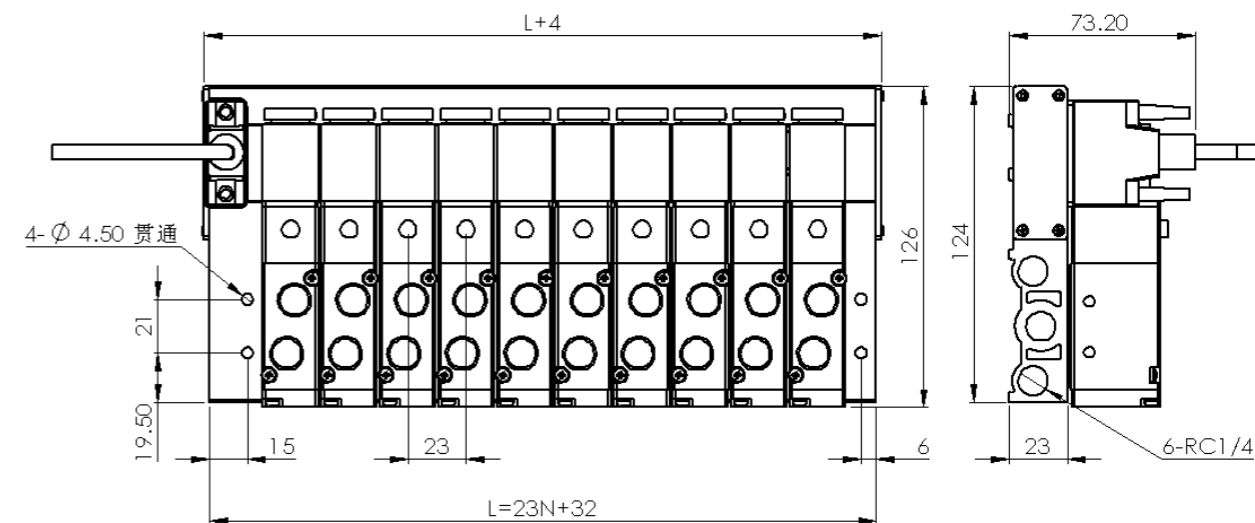

位数	4	5	6	7	8	9	10	11	12	13	14
L	124	147	170	193	216	239	262	285	308	331	354

AirTAC 汇流板系列
MANIFOLD SERIES



AirTAC 100M series



AirTAC 200M series



AirTAC 300M series



AirTAC 400M series



AirTAC VF3000 series



AirTAC VF5000 series



AirTAC 3V110 series



AirTAC 3V210 series



AirTAC 3V310 series



AirTAC 3V410 series



AirTAC HD100M series



AirTAC HD200M series



AirTAC 200M thickness series



AirTAC 4M310 / 4M210 series



AirTAC 4V blanking plate

CKD 汇流板系列
MANIFOLD SERIES

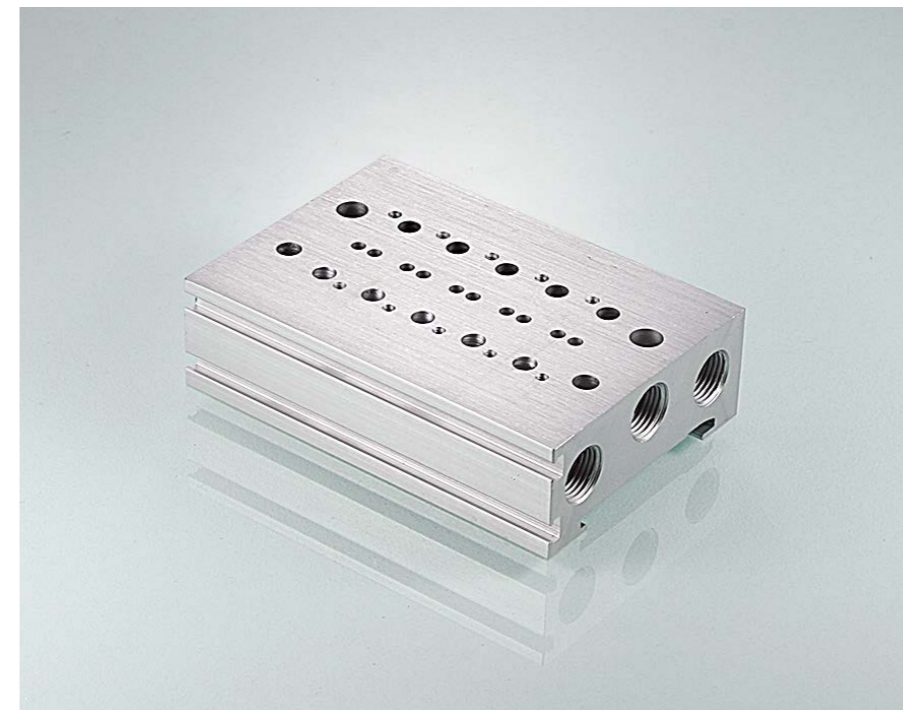

CKD 4GA1/4GD1 series

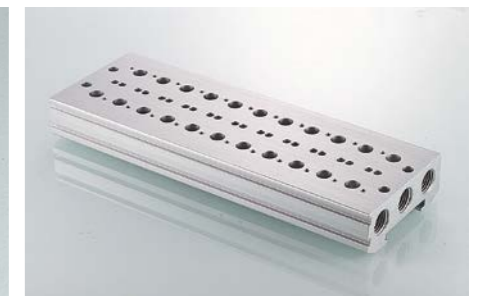

CKD 4GA2/4GD2 series



CKD 4GA3/4GD3 series



CKD 3PA1 series



CKD 3PA2 series



CKD 4GB1/4GE1 series

SMC 汇流板系列
MANIFOLD SERIES



SMC SS5Y3 series



SMC SS5Y5 series



SMC SS5Y7 series



SMC SS5Y9 series



SMC SS5Y3-41 series



SMC SS5Y5-41 series



SMC SS5Y7-42 series



SMC VF3000 series



SMC VF5000 series



SMC 5YJ3 series



SMC 5YJ5 series



SMC SY blanking plate

Parker 汇流板系列
MANIFOLD SERIES



Parker P2LA series

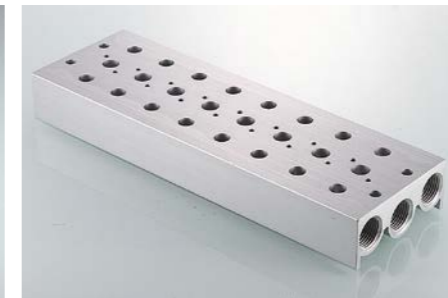

Parker P2LA series



Parker P2LA P2LB series



Parker P2LB series



Parker P2LC series



Parker P2LC series

Mindman
汇流板系列
MANIFOLD SERIES



MINDMAN MVSC-180 series



MINDMAN MVSC-220 series



MINDMAN MVSA-260 series



MINDMAN MVSA-300 series



MINDMAN MVSC-460 series

KOGANEI
小金井
汇流板系列
MANIFOLD SERIES



KOGANEI 110 series



KOGANEI 180 series



KOGANEI 180 series



KOGANEI F10M series



KOGANEI blanking plate

ISO5599/1 汇流板系列
MANIFOLD SERIES



ISO1 1/4" series



ISO2 3/8" series



ISO3 1/2" series



ISO3 3/4" series



ISO1 1/4" Parallel manifold series



ISO2 3/8" Parallel manifold series

KURODA
PRECISION INDUSTRIES LTD.
黑田
汇流板系列
MANIFOLD SERIES



KURODA RCL 2413 series



KURODA PEP34 series



KURODA PHS-510 series



KURODA PEP34-1 series

NORGREN

汇流板系列
MANIFOLD SERIES



NORGREN V60 series



NORGREN V61 series



NORGREN V62 series

FESTO

汇流板系列
MANIFOLD SERIES



FESTO VUUG/VUWG M5 series



FESTO VUUG/VUWG M7 series



FESTO VUUG/VUWG 1/8" series



FESTO VUUG/VUWG 1/4" series



FESTO VUUS 1/8" series



FESTO PRS 1/8" series

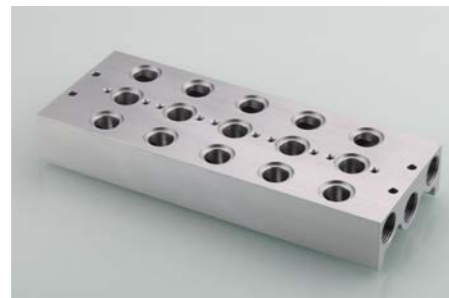

FESTO PRS 1/4" series



FESTO VUUG 1/4" 1/8" M5 blanking plate series

SPECIAL CUSTOMIZING

汇流板系列
MANIFOLD SERIES

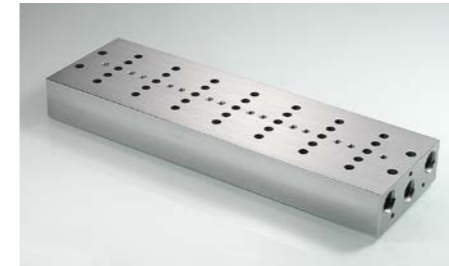

Special customizing MO



Special customizing



Special customizing



Special customizing HX-B



Special customizing HX-A



Special customizing AT



Special customizing AT-C



Special customizing 15MM



Special customizing ZBF5050



Special customizing PL143-180

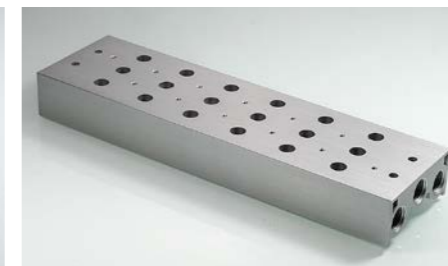

ASCO YA2 series



Manifold Block Splitter (1/2")



Manifold Block Splitter (1/4")

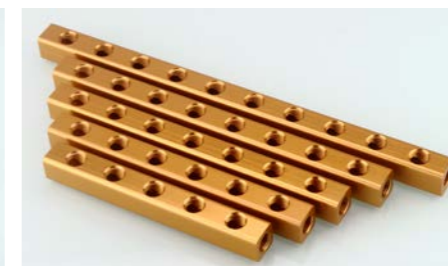

Manifold Block Splitter (1/2")

